



**JSF**  
TECHNOLOGIES  
SOLAR TRAFFIC SOLUTIONS

www.JSFTech.com

sales@JSFTech.com

1-800-990-2454



# AB-7400-20W

## Pedestrian Activated Flashing Beacon



### SELF-CONTAINED 20 WATT SOLAR ENGINE

	<b>Solar Panel</b> Solar Cell - Monocrystalline Silicon Rated Power (Pmp) 20 Watts Rated Voltage (Vmp) 18 VDC Rated Current (Imp) 1.1 Amps CE and TUV certified
	<b>Solar Angle</b> 44° (Standard)
	<b>Standard Battery Bank</b> AGM 12V, 18 Ah - UL Recognized, field replaceable
	<b>Cold Weather Battery Bank Option</b> AGM 12V, 16 Ah - UL Recognized, field replaceable
	<b>Solar Engine Housing Material</b> A5052 Sheet Aluminum (Enclosure) 6061-T6 Aluminum (Mount)
	<b>Solar Engine Dimensions</b> 15.75" x 13.25" X 4.5" (40 x 33.7 x 11.5cm)*

### POWER MANAGEMENT

	<b>Rated Usage</b> 300 cycles per day, 25 second activation
	<b>Charged Capacity</b> Up to 30 days at rated usage
	<b>Automatic Light Control (ALC)</b> Various stages of brightness for different solar conditions and battery levels

### SYSTEM PROTECTION

	<b>Low Voltage Disconnect</b> 9.5 VDC
	<b>Over Current Protection</b> 1.8 Amp PTC auto-reset fuse
	<b>Self Monitoring</b> Visual notification of sub-optimal operation

### LED BEACON SIGNAL HEAD

	<b>Standard Followed</b> ITE VTCSH-STD 2005
	<b>LED Beacon Signal Head Setup</b> Dual Heads, Vertical Pole Mounting
	<b>Lens Material</b> UV stabilized polycarbonate and Abrasion resistant
	<b>LED Housing</b> 100% Polycarbonate
	<b>LED Size</b> 8" Diameter (200 mm)* 12" Diameter (300mm)*
	<b>LED Housing Dimensions</b> 8" head - 14" x 10" x 6" (35 x 25 x 16 cm)* 12" head - 17" x 14" x 6" (44 x 25 x 17 cm)*
	<b>Std. LED Color Options</b> Amber or Red (custom colors available)

### COMMUNICATION

	<b>Band of Operation</b> ISM Band (902-928 MHz)
	<b>Compliance</b> FCC and IC Compliant
	<b>Range</b> Up to 0.5 miles (800 m) with line of sight
	<b>Network Addresses</b> 16 unique addresses to avoid interference between multiple crosswalk locations
	<b>Compatibility</b> Can communicate with other AB units

### SYSTEM OPTIONS

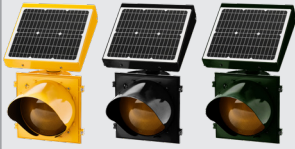
	<b>LED &amp; Solar Engine Housing Colors</b> Yellow, Black or Green (custom colors available) 
	<b>Mounting Options</b> Side Mount Bracket: 12", and 18" and custom lengths available Signal & Solar Head Side Mount Bracket Custom Mounts Available

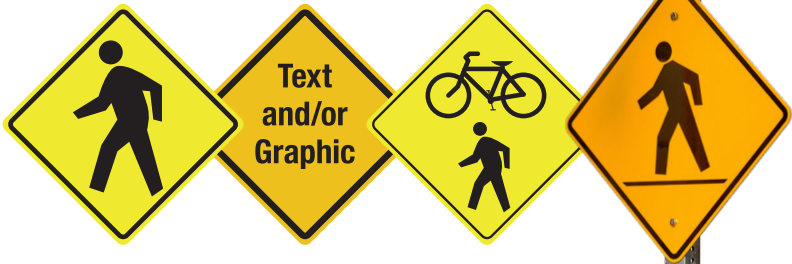

AVAILABLE WITH ANY STANDARD SIGN.  
CUSTOM SIGNS ARE AVAILABLE

AVAILABLE WITH RED LEDS FOR STOP SIGNS, AMBER LEDS FOR WARNING SIGNS

## SYSTEM OVERVIEW

<b>Compliance</b>	FHWA MUTCD Compliant
<b>Standard Operation</b>	Pedestrian Activated via push button or JSFT remote transmitters
<b>Flash Pattern Options</b>	MUTCD Standard (0.5 seconds ON, 0.5 seconds OFF) JSFT Strobe Energy Efficient Flash Pattern** MUTCD Wig - Wag JSFT Wig - Wag Strobe Energy Efficient Flash Pattern**
<b>Activation Duration</b>	Variable from 5 seconds to 4 hours
<b>Std. Operating Temperature</b>	14°F to +165°F (-10°C to +74°C)
<b>Cold Weather Upgrade Option</b>	-40°F to +176°F (-40°C to +80°C)
<b>System Voltage</b>	12 VDC
<b>Packaged Dimensions</b>	8" head - 36" x 18" x 18" @ 74 lbs (91.5 x 45.7 x 45.7cm @ 34 kg)* 12" head - 36" x 18" x 18" @ 80 lbs (91.5 x 45.7 x 45.7cm @ 36 kg)*

<b>SALES</b> Toll-Free 1.800.990.2454 sales@jsftech.com	<b>SUPPORT</b> Toll-Free 1.800.990.2454 support@jsftech.com	<b>ADDRESS</b> 6582 Bryn Road, Victoria, BC V8M 1X6
---	---	---

**WARRANTY** 5-year Limited Warranty for defects in workmanship and materials (excludes batteries and vandalism)



**AB-7400-20W**  
Pedestrian Activated Flashing Beacon

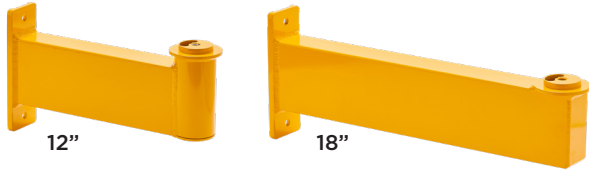

SIDE MOUNT BRACKET



SIGNAL HEAD & SOLAR ENGINE  
SIDE MOUNT BRACKET

**SIGNAL HEAD MOUNTING OPTIONS**

**SOLAR ENGINE MOUNTING OPTIONS**

ISO VIEW

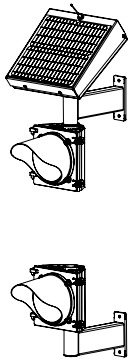

AB-7408-20W

FRONT VIEW

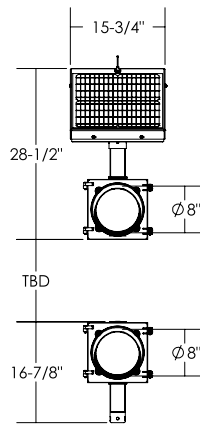

SIDE VIEW

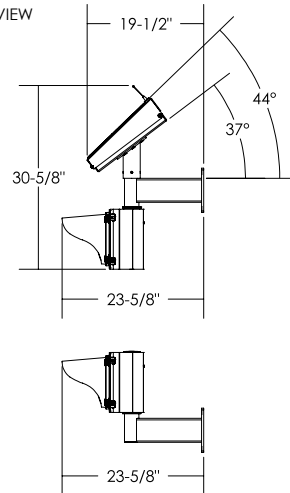

ISO VIEW

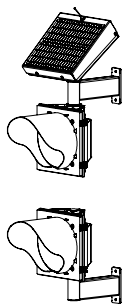

AB-7412-20W

FRONT VIEW

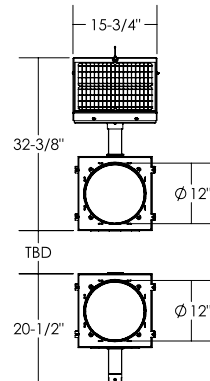

SIDE VIEW

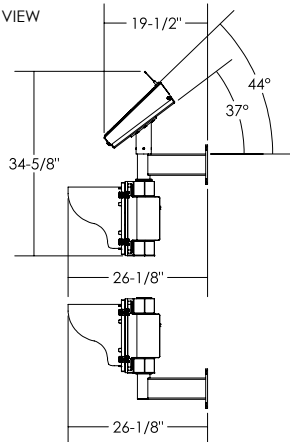

**SYSTEM DRAWINGS**

# AB-7400-40W

## Pedestrian Activated Flashing Beacon



### SELF-CONTAINED 40 WATT SOLAR ENGINE

<b>Solar Panel</b>	Solar Cell - Monocrystalline Silicon Rated Power (Pmp) 40 Watts Rated Voltage (Vmp) 18 VDC Rated Current (Imp) 2.2 A Certifications: CE and TUV certified
--------------------	---

<b>Solar Angle</b>	44° (Standard)
<b>Standard Battery Bank</b>	2 x AGM 12V, 18 Ah - UL Recognized, field replaceable
<b>Cold Weather Battery Bank Option</b>	2 x AGM 12V, 16 Ah - UL Recognized, field replaceable
<b>Solar Engine Housing Material</b>	A5052 Sheet Aluminum (Enclosure) 6061-T6 Aluminum (Mount)
<b>Solar Engine Dimensions</b>	30.875" x 13.25" x 4.5" (78.4 x 33.7 x 11.5cm)*

### POWER MANAGEMENT

<b>Rated Usage</b>	300 cycles per day, 25 second activation
<b>Charged Capacity</b>	Up to 30 days at rated usage
<b>Automatic Light Control (ALC)</b>	Various stages of brightness for different solar conditions and battery levels

### SYSTEM PROTECTION

<b>Low Voltage Disconnect</b>	9.5 VDC
<b>Over Current Protection</b>	1.8 Amp PTC auto-reset fuse
<b>Self Monitoring</b>	Visual notification of sub-optimal operation

### LED BEACON SIGNAL HEAD

<b>Standard Followed</b>	ITE VTCOSH-STD 2005
<b>LED Beacon Signal Head Setup</b>	Dual Heads, Vertical Pole Mounting
<b>Lens Material</b>	UV stabilized polycarbonate and Abrasion resistant
<b>LED Housing</b>	100% Polycarbonate
<b>LED Size</b>	8" Diameter (200 mm)* 12" Diameter (300mm)*
<b>LED Housing Dimensions</b>	8" head - 14" x 10" x 6" (35 x 25 x 16 cm)* 12" head - 17" x 14" x 6" (44 x 25 x 17 cm)*
<b>Std. LED Color Options</b>	Amber or Red (custom colors available)

### COMMUNICATION

<b>Band of Operation</b>	ISM Band (902-928 MHz)
<b>Compliance</b>	FCC and IC Compliant
<b>Range</b>	Up to 0.5 miles (800 m) with line of sight
<b>Network Addresses</b>	16 unique addresses to avoid interference between multiple crosswalk locations
<b>Compatibility</b>	Can communicate with other AB units

### SYSTEM OPTIONS

<b>LED &amp; Solar Engine Housing Colors</b>	Yellow, Black or Green (custom colors available)
--	--

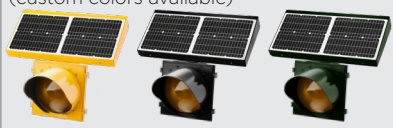

<b>Mounting Options</b>	Side Mount Bracket: 12", and 18" and custom lengths available Signal & Solar Head Side Mount Bracket Custom Mounts Available
-------------------------	--

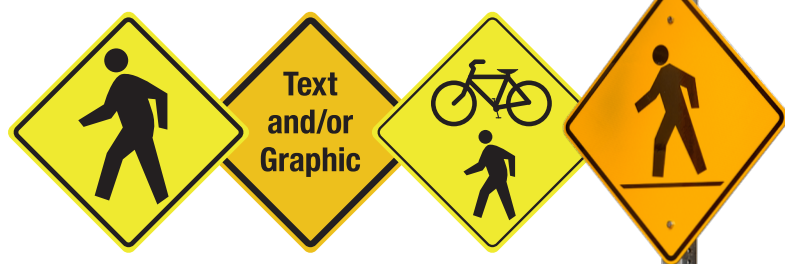

AVAILABLE WITH ANY STANDARD SIGN.  
CUSTOM SIGNS ARE AVAILABLE



AVAILABLE WITH RED LEDS FOR STOP SIGNS, AMBER LEDS FOR WARNING SIGNS

## SYSTEM OVERVIEW

<b>Compliance</b>	FHWA MUTCD Compliant
<b>Standard Operation</b>	Pedestrian Activated via push button or JSFT remote transmitters
<b>Flash Pattern Options</b>	MUTCD Standard (0.5 seconds ON, 0.5 seconds OFF) JSFT Strobe Energy Efficient Flash Pattern** MUTCD Wig - Wag JSFT Wig - Wag Strobe Energy Efficient Flash Pattern**
<b>Activation Duration</b>	Variable from 5 seconds to 4 hours
<b>Std. Operating Temperature</b>	14°F to +165°F (-10°C to +74°C)
<b>Cold Weather Upgrade Option</b>	-40°F to +176°F (-40°C to +80°C)
<b>System Voltage</b>	12 VDC
<b>Packaged Dimensions</b>	8" head - 36" x 18" x 18" @ 74 lbs (91.5 x 45.7 x 45.7cm @ 34 kg)* 12" head - 36" x 18" x 18" @ 80 lbs (91.5 x 45.7 x 45.7cm @ 36 kg)*

**SALES**  
Toll-Free 1.800.990.2454  
sales@jsftech.com

**SUPPORT**  
Toll-Free 1.800.990.2454  
support@jsftech.com

**ADDRESS**  
6582 Bryn Road,  
Victoria, BC V8M 1X6

**WARRANTY** 5-year Limited Warranty for defects in workmanship and materials (excludes batteries and vandalism)



**AB-7400-40W**  
Pedestrian Activated Flashing Beacon

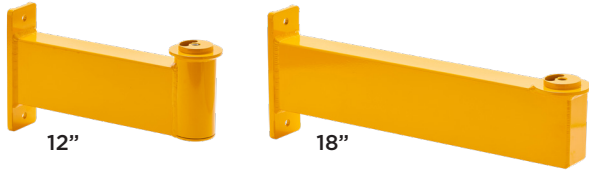

SIDE MOUNT BRACKET

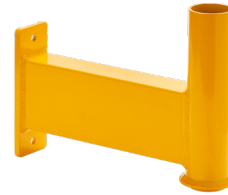

SIGNAL HEAD & SOLAR ENGINE  
SIDE MOUNT BRACKET

**SIGNAL HEAD MOUNTING OPTIONS**

**SOLAR ENGINE MOUNTING OPTIONS**

ISO VIEW

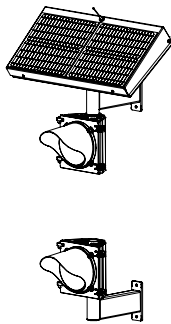

AB-7408-40W

FRONT VIEW

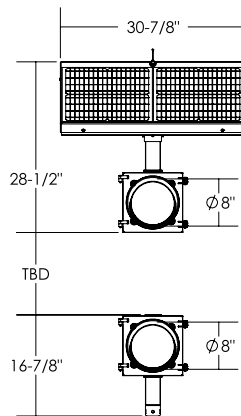

SIDE VIEW

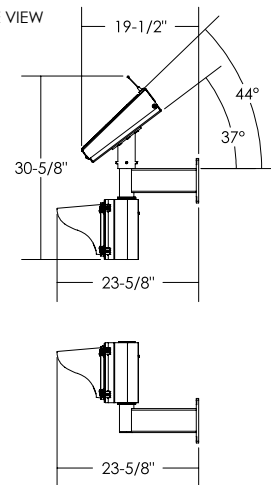

ISO VIEW

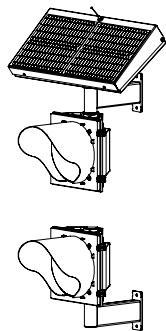

AB-7412-40W

FRONT VIEW

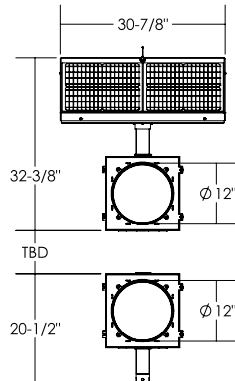

SIDE VIEW

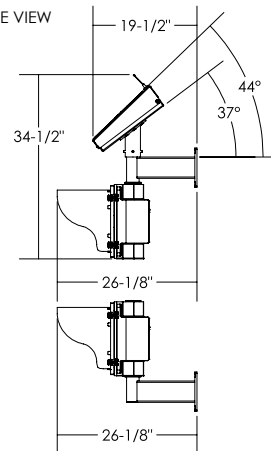

**SYSTEM DRAWINGS**

# AB-7400-AC

## Pedestrian Activated Flashing Beacon



### AC ENCLOSURE

Enclosure Material	0.08" Type 5052 H-32 aluminum
Enclosure Dimensions (Small)	12" x 12" x 4" (30 x 30 x 10cm)*
Enclosure Dimensions (Large)	16" x 14" x 8" (41 x 36 x 20cm)*
Standards	UL 508 Type 3R, 4, 4X, 12, and 13 CSA Type 3R, 4, 4X, 12, and 13
Compliance	NEMA Type 3R, 4, 4X, 12 and 13 JIC EGP-1-1967 IEC 60529, IP66
Enclosure Colors	Aluminum, Black, Green or Yellow (Custom Colors Available)



### AC BRICK SPECIFICATIONS

Dimensions	6.375" x 1.625" x 1.25" @ 0.9 lbs (16.25 x 4.3 x 3.2 cm @ 0.41 kg)*
Power Supply Rating	120 VAC to 15 VDC Class 2 Supply
Standards	IP67, CE Certified, UL Recognized

### SYSTEM PROTECTION

Over Current Protection	1.8 Amp PTC auto-reset fuse
Self Monitoring	Visual notification of sub-optimal operation

### LED BEACON SIGNAL HEAD

Standard Followed	ITE VTCOSH-STD 2005
LED Beacon Signal Head Setup	Dual Heads, Vertical Pole Mounting
Lens Material	UV stabilized polycarbonate and Abrasion resistant
LED Housing	100% Polycarbonate
LED Size	8" Diameter (200 mm)* 12" Diameter (300mm)*
LED Housing Dimensions	8" head - 14" x 10" x 6" (35 x 25 x 16 cm)* 12" head - 17" x 14" x 6" (44 x 25 x 17 cm)*
Std. LED Color Options	Amber or Red (custom colors available)

### COMMUNICATION

Band of Operation	ISM Band (902-928 MHz)
Compliance	FCC and IC Compliant
Range	Up to 0.5 miles (800 m) with line of sight
Network Addresses	16 unique addresses to avoid interference between multiple crosswalk locations
Compatibility	Can communicate with other AB units

### SYSTEM OPTIONS

LED Housing Colors	Yellow, Black or Green (custom colors available)
--------------------	---



Mounting Options	Side Mount Bracket: 12", and 18" and custom lengths available Custom Mounts Available
------------------	---



7408-AC  
8" Amber LEDs



AVAILABLE WITH ANY STANDARD SIGN.  
CUSTOM SIGNS ARE AVAILABLE



AVAILABLE WITH RED LEDS FOR STOP  
SIGNS, AMBER LEDS FOR WARNING SIGNS

## SYSTEM OVERVIEW

Compliance	FHWA MUTCD Compliant
Standard Operation	Pedestrian Activated via push button or JSFT remote transmitters
Flash Pattern Options	MUTCD Standard (0.5 seconds ON, 0.5 seconds OFF) JSFT Strobe Energy Efficient Flash Pattern** MUTCD Wig - Wag JSFT Wig - Wag Strobe Energy Efficient Flash Pattern**
Activation Duration	Variable from 5 seconds to 4 hours
Std. Operating Temperature	-40°F to +176°F (-40°C to +80°C)
System Voltage	12 VDC
Packaged Dimensions	Varies depending on configuration and installation method

### SALES

Toll-Free 1.800.990.2454  
sales@jsftech.com

### SUPPORT

Toll-Free 1.800.990.2454  
support@jsftech.com

### ADDRESS

6582 Bryn Road,  
Victoria, BC V8M 1X6

**WARRANTY** 5-year Limited Warranty for defects in workmanship and materials (excludes batteries and vandalism)



# AB-7400-AC

Pedestrian Activated Flashing Beacon

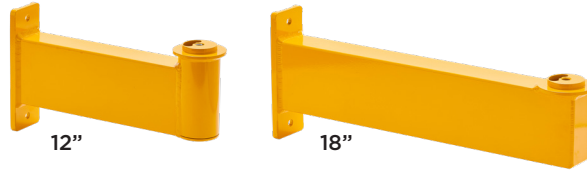

SIDE MOUNTBRACKET

## SIGNAL HEAD MOUNTING OPTIONS

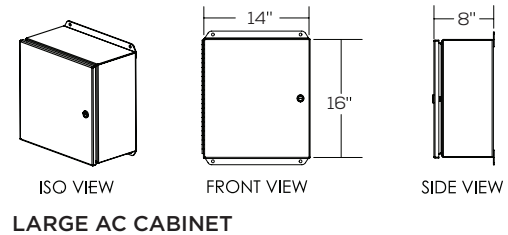
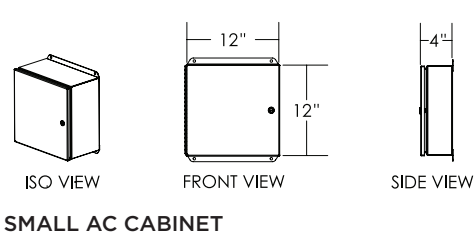
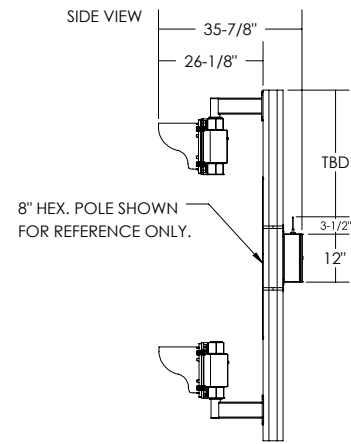
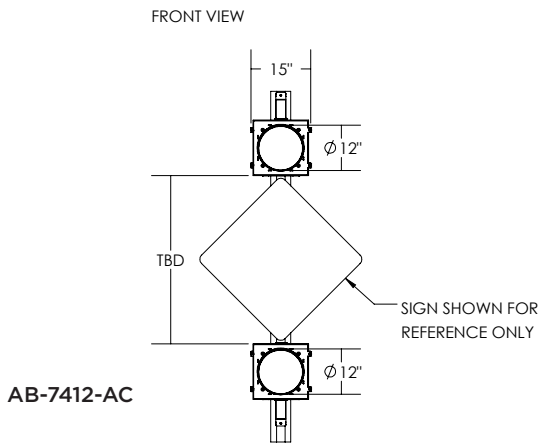
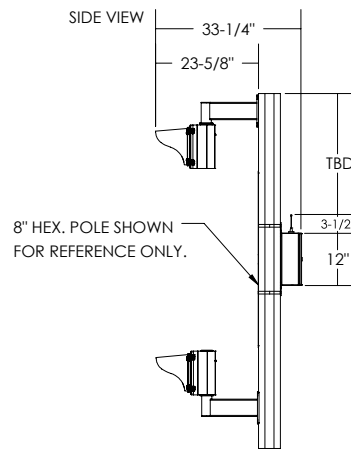
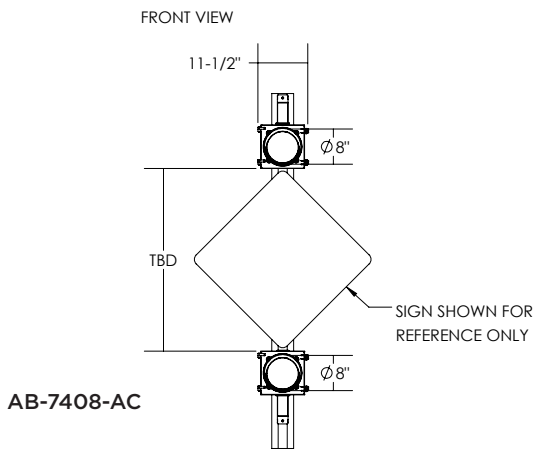

## SYSTEM DRAWINGS